

3 TROCARTS

Sondes, canules

*Trocars, probes,
suction cannulae*

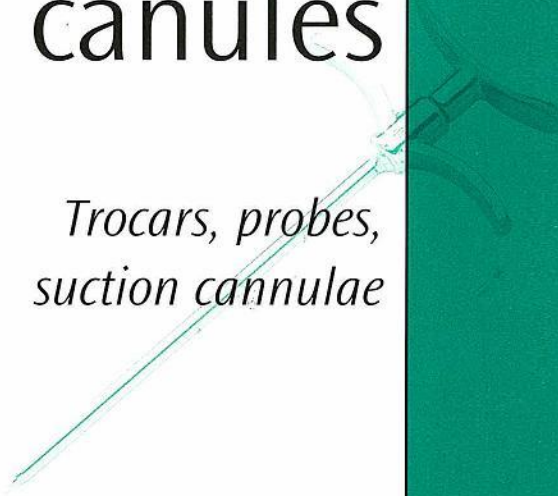

Cotton applicators - Sonde

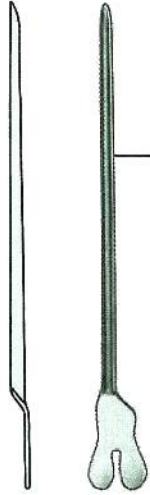

SONDE CANNELEE

- 180-101-000** 13 cm
- 180-102-000** 14,5 cm
- 180-103-000** 16 cm

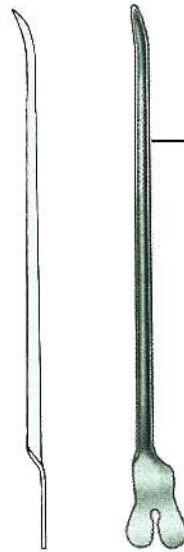

DOYEN

- 180-132-000** 14,5 cm

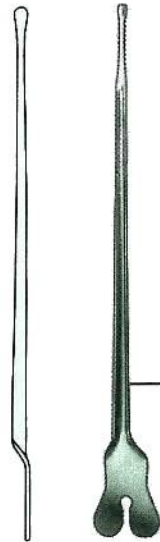

NELATON

- 180-273-000** 16 cm

NELATON

- 180-112-000** 14 cm
- 180-113-000** 16 cm
- 180-114-000** 18 cm
- 180-115-000** 20 cm

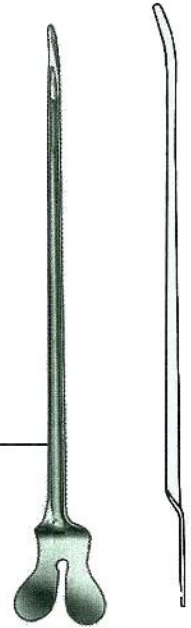

STYLET-OLIVAIRE

Ø 2 mm

- 180-221-000** 13 cm
- 180-222-000** 14,5 cm
- 180-223-000** 16 cm
- 180-224-000** 18 cm
- 180-225-000** 20 cm
- 180-226-000** 25 cm
- 180-227-000** 30 cm



STYLET AIGUILLE

Ø 1,5 mm

- 180-251-000** 13 cm
- 180-252-000** 14,5 cm
- 180-253-000** 16 cm
- 180-254-000** 18 cm
- 180-255-000** 20 cm
- 180-256-000** 25 cm
- 180-257-000** 30 cm

Ø 1,5 mm

- 180-281-000** 13 cm
- 180-282-000** 14,5 cm
- 180-283-000** 16 cm



CANULES A ASPIRATION

Suction cannulae

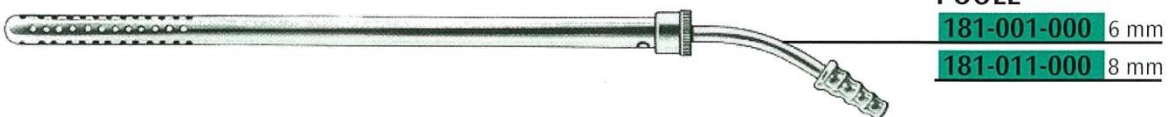
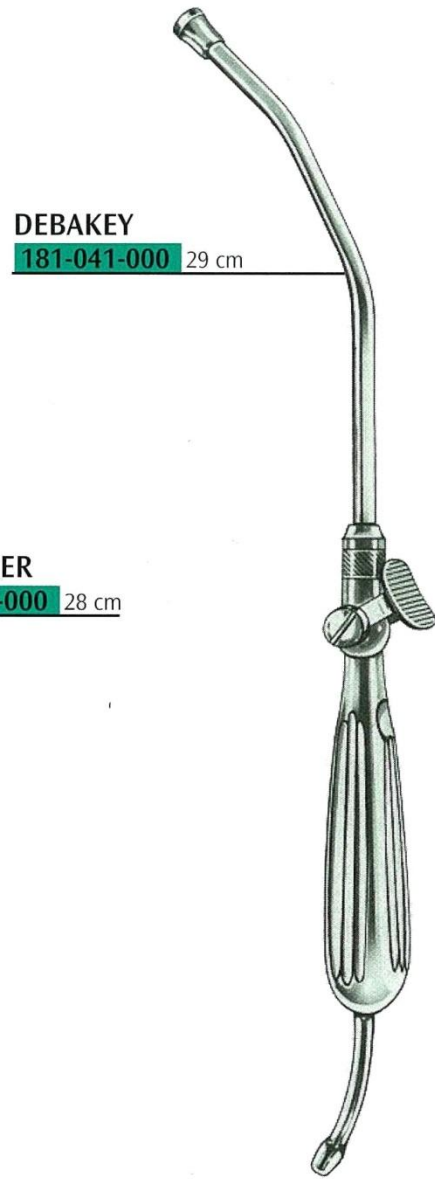
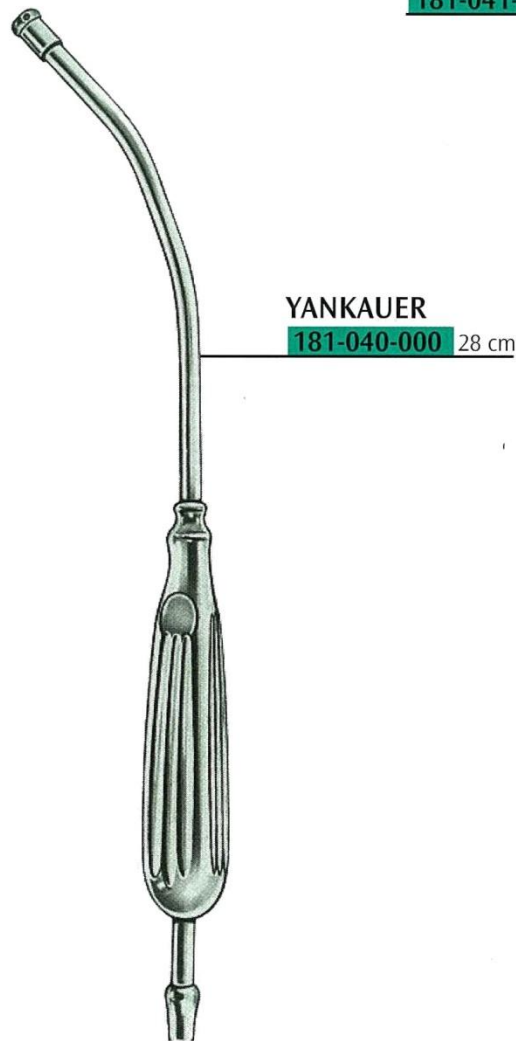
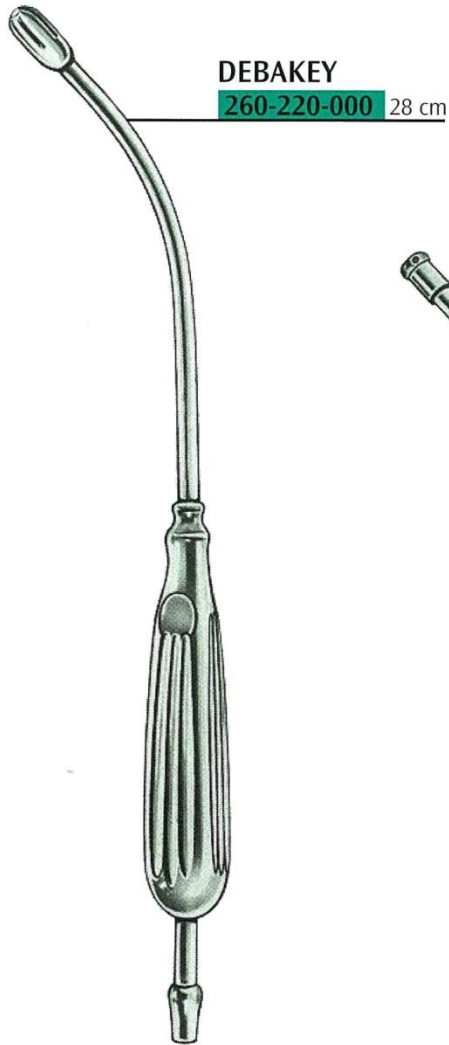

Trocarts

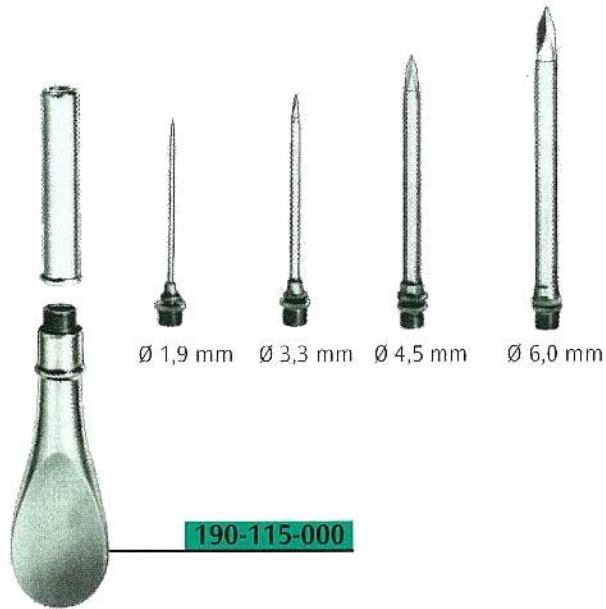

**PLEUROTOME
(trocart de Monod)**

bout mousse/blunt

23 cm

- 190-012-016** charrière 16
- 190-012-018** charrière 18
- 190-012-020** charrière 20
- 190-012-022** charrière 22
- 190-012-024** charrière 24



NELSON

17 cm

- 190-050-000** 3,0/2,2 mm
- 190-051-000** 3,5/2,5 mm
- 190-052-000** 4,0/3,0 mm
- 190-053-000** 4,5/3,5 mm
- 190-054-000** 5,0/4,0 mm
- 190-055-000** 5,5/4,5 mm
- 190-056-000** 6,0/5,0 mm
- 190-057-000** 6,5/5,5 mm
- 190-060-000** 11,0/10,0 mm

Trocarts

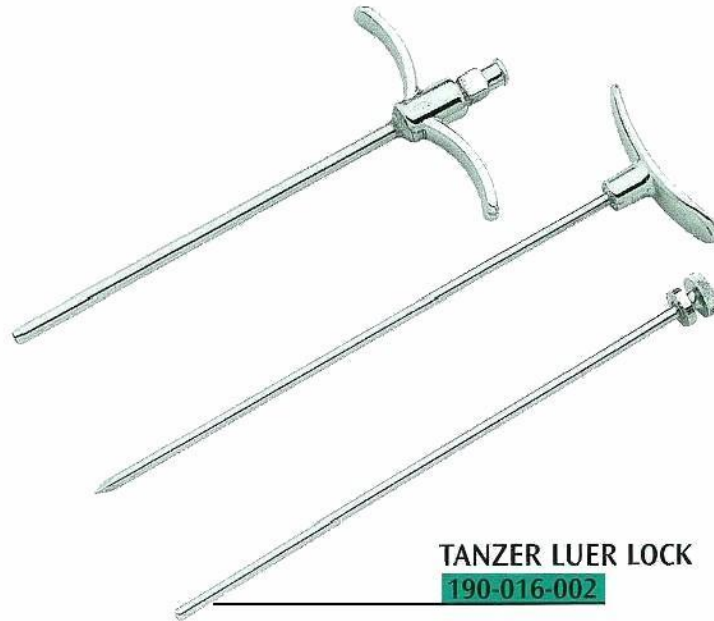

TANZER LUER LOCK
190-016-002

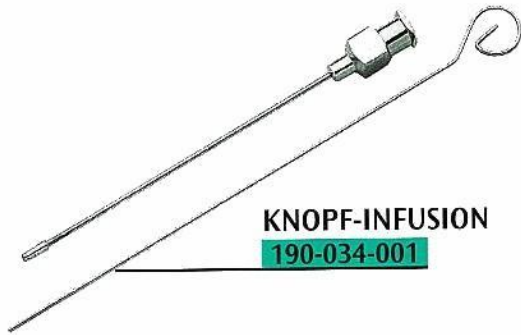

KNOFF-INFUSION
190-034-001

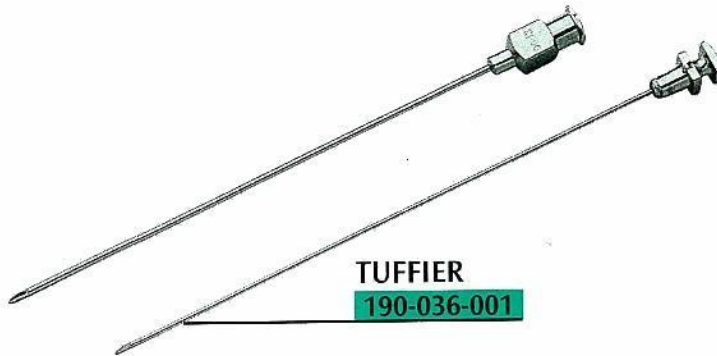

TUFFIER
190-036-001

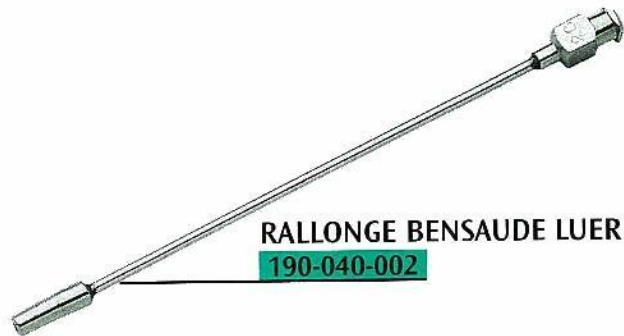

RALLONGE BENSAUDE LUER
190-040-002

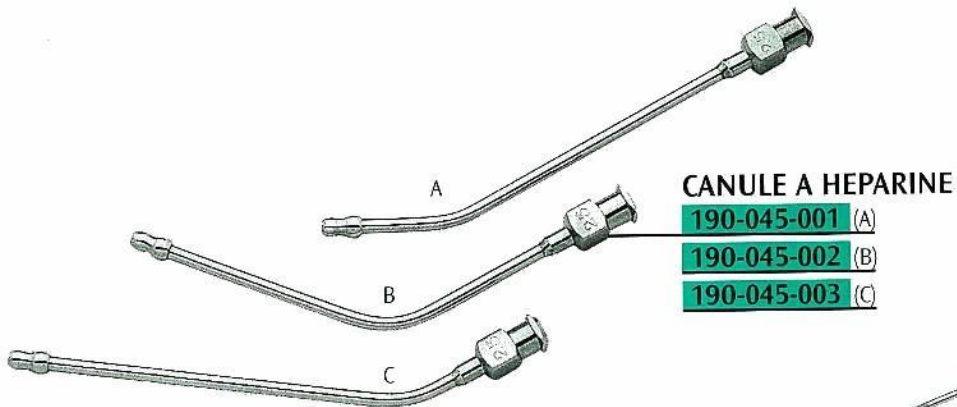

CANULE A HEPARINE
190-045-001 (A)
190-045-002 (B)
190-045-003 (C)



AIGUILLE DE MINTZ
190-038-003